



COMPRESSION FITTINGS CATALOGUE



MASTER <

Box type	Dimensions
B	60x30x40 cm
C	40x30x30 cm

> COMPRESSION FITTINGS - GENERAL CHARACTERISTICS

DESCRIPTION

Astore PP compression fittings are joints for PE pipes dedicated to water adduction systems. They can be used both in irrigation field and drinking water systems.

RANGE

Astore joints range includes a large number of items apt to satisfy a very wide range of plant engineering installation requirements. The joints range leaves from D 16 mm up to D 110 mm. The joints provided with threads have a metal reinforcement on the external part of the thread, leaving from R 1 1/4".

MATERIALS

Body and nut in polypropylene black co-polymer, clinching ring in white POM resin, O-ring in NBR, reinforcement ring in AISI 430.

REFERENCE STANDARDS

Astore compression fitting is manufactured in compliance with the requirements of standards DIN 8076-3, UNI 9561, ISO 17885.

The joints can be installed on PE pipes which are in compliance with standards ISO 4427, DIN 8072, DIN 8074, UNI EN 12201. The threaded versions are manufactured in compliance with standard ISO 7-1.

PRESSURE RATING AT 20° C

16 bar from D 16 mm up to D 63 mm, 10 bar from D 75 mm up to D 110 mm.

Astore compression fittings are approved by DVGW (DW-8616BQ0078).

> GIUNTI A COMPRESSIONE - CARATTERISTICHE GENERALI

DESCRIZIONE

I giunti a compressione in PP Astore sono raccordi di collegamento per tubi in PE dedicati agli impianti per il trasporto acqua. Utilizzabili sia nel segmento irriguo, sia negli impianti d'acqua potabile e da potabilizzare.

GAMMA

La gamma dei giunti Astore prevede numerose figure atte a soddisfare le più svariate esigenze impiantistiche dell'installatore. Le dimensioni del giunto partono da D 16 mm fino a D 110 mm. I giunti provvisti di filettatura prevedono a partire da R 1 1/4" un rinforzo metallico sulla parte esterna della filettatura.

MATERIALI

Corpo e ghiera in polipropilene copolimero nero, anello di graffaggio in resina acetica bianca, guarnizione toroidale in NBR, anello di rinforzo in AISI 430. Flange metalliche (art. 520) FE 360, zincato.

NORME DI RIFERIMENTO

Il giunto a compressione Astore è realizzato secondo le prescrizioni delle norme DIN 8076-3, UNI 9561, ISO 17885.

Il giunto può essere installato su tubazioni in PE che seguono le norme ISO 4427, DIN 8072, DIN 8074, UNI EN 12201.

Le versioni provviste di filettatura sono realizzate secondo la norma ISO 7-1.

PRESSIONI DI ESERCIZIO

A 20° C dal D 16 mm al D 63 mm 16 bar, dal D 75 mm a D 110 mm 10 bar.

I giunti a compressione Astore sono approvati DVGW (DW-8616BQ0078).

> KLEMMVERBINDUNGERN - ALLGEMEINE EIGENSCHAFTEN

BESCHREIBUNG

Die Druckanschlüsse aus Polypropylen von Astore sind Verbindungsstücke für Rohre aus Polyethylen, die in Wasserdurchlaufanlagen eingesetzt werden. Sie sind sowohl im Bewässerungsbereich, als auch für Trinkwasser-Bereitungsanlagen einsetzbar.

PRODUKTPALETTE

Die Produktpalette der Anschlüsse von Astore umfassen zahlreiche Typen, die den unterschiedlichsten Anforderungen hinsichtlich der Anlage oder der Installation gerecht werden.

Die Durchmesser der Anschlüsse reichen von 16 mm bis zu 110 mm. Die Gewindeanschlüsse haben ab einem Durchmesser von 1 1/4" eine Metallverstärkung auf der Außenseite des Gewindes.

MATERIALIEN

Körper und Überwurfmutter sind aus schwarzem Polypropylen Copolymer, der Klemmring ist aus weißem Acetatkunstharz, die ringförmige Dichtung aus NBR, der Verstärkungsring aus AISI 430. Der Flansch (art. 520) aus Chromstahl.

NORM VORSCHRIFTEN

Der Druckanschluß von Astore wird unter Einhaltung der Vorschriften folgender Normen hergestellt: DIN 8076-3, UNI 9561, ISO 17885.

Der Anschluß kann an Rohren aus Polyethylen, die den Normen ISO 4427, DIN 8072, DIN 8074, UNI EN 12201 entsprechen, angebracht werden.

Die Gewindeausführungen entsprechen der Norm ISO 7-1.

DRUCK BEI INBETRIEBNAHME

Bei 20° C von Durchmesser 16 mm bis Durchmesser 63 mm: 16 bar, von Durchmesser 75 mm bis Durchmesser 110 mm: 10 bar.

Die Klemmverbindungen Astore sind nach DVGW (DW-8616BQ0078) Zertifiziert.

> RACCORD À COMPRESSION - CARACTÉRISTIQUES GÉNÉRALES

DESCRIPTION

Les joints à compression en PP Astore sont des raccords de liaison pour tuyaux en PE utilisés dans les systèmes de transport d'eau. Les joints peuvent être utilisés soit pour les circuits d'eau potable ou à rendre potable que pour les reseaux d'irrigation.

GAMME

La gamme des joints Astore prévoit de nombreux produits aptes à satisfaire les exigences des installateurs.

Les dimensions vont du D 16 mm au D 110 mm.

Concernant les joints taraudés, à partir de R 1 1/4", il est prévu un renforcement métallique sur la partie extérieure des filets.

MATÉRIAUX

Le corps et la douille sont en polypropylène noir, la bague d'agrafage en résine acétal blanche, les joints de garniture en NBR, la bague de renforcement en acier inox AISI 430. Brides en acier zingue (art. 520).

NORMES DE RÉFÉRENCE

Les joints à compression Astore sont réalisés selon les normes DIN 8076-3, UNI 9561, ISO 17885.

Ces joints peuvent être montés dans des tuyauteries PE conformes aux normes ISO 4427, DIN 8072, DIN 8074, UNI EN 12201.

Les versions filetées et taraudées sont réalisées conformément à la norme ISO 7-1.

PRESSIONS D'EXERCICE

A 20° C du D 16 mm au D 63 16 bars, du D 75 mm au D 110 mm 10 bars.

Les raccords à compression Astore sont approuvés DVGW (DW-8616BQ0078).

> JUNTAS DE COMPRESIÓN - CARACTERÍSTICAS GENERALES

DESCRIPCIÓN

Los racores de compresión de PP Astore se utilizan en tubos de PE para conducciones de agua. Son igualmente idóneos para instalaciones de riego, agua potable y para conducciones de potabilización.

GAMA

La gama de racores Astore ofrece numerosas piezas, para cubrir las más variadas exigencias del instalador. Los diámetros van de 16 mm a 110 mm.

Los racores roscados, a partir del diámetro de 1 1/4", llevan un refuerzo metálico en el exterior de la rosca.

MATERIALES

Cuerpo y abrazadera de polipropileno copolimerizado negro, collarín de cierre en resina de acetal blanca, junta torica de NBR, collarín de refuerzo en acero AISI 430. Arandela (art. 520) de acero zincado.

NORMAS DE REFERENCIA

El racor de compresión Astore cumple las normas DIN 8076-3, UNI 9561, ISO 17885.

Es compatible con las tuberías de PE conformes a las normas ISO 4427, DIN 8072, DIN 8074, UNI EN 12201.

Las versiones roscadas están realizadas con arreglo a la norma ISO 7-1.

PRESIÓN DE TRABAJO

A 20° C, del D 16 mm al D 63 mm 16 bar; del D 75 mm al D 110 mm 10 bar.

El junta de compresión Astore ha recibido el certificado DVGW (DW-8616BQ0078).

> D 16÷63

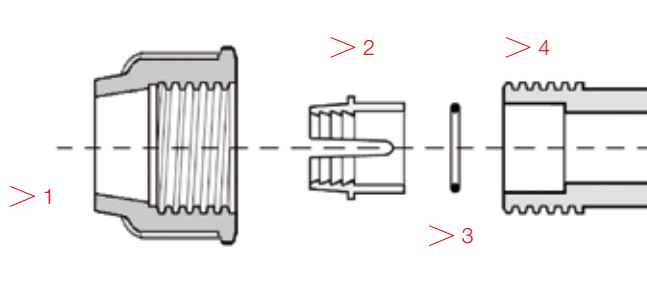

COMPONENTS DESCRIPTION

- 1) Nut
- 2) Clinching ring
- 3) O-ring
- 4) Body

DESCRIZIONE COMPONENTI

- 1) Ghiera
- 2) Anello di graffaggio
- 3) Guarnizione toroidale
- 4) Corpo

BESCHREIBUNG DER STÜCKE

- 1) Überwurfmutter
- 2) Klemmring
- 3) O-ring Dichtung
- 4) Grundkörper

DESCRIPTION DES PIÈCES

- 1) Ecrou
- 2) Bague de serrage
- 3) Garniture O-ring
- 4) Corp

DESCRIPCIÓN DE LAS PIEZAS

- 1) Tuerca
- 2) Anillo de cerrado
- 3) Junta tórica
- 4) Cuerpo

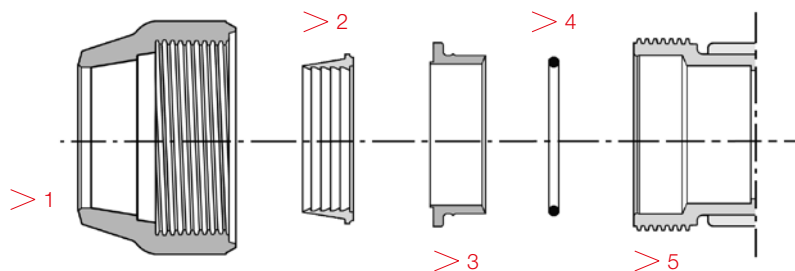

**COMPONENTS
DESCRIPTION**

- 1) Nut
- 2) Clinching ring
- 3) Thrust bushing
- 4) O-ring
- 5) Body

**DESCRIZIONE
COMPONENTI**

- 1) Ghiera
- 2) Anello di graffaggio
- 3) Bussola di spinta
- 4) Guarnizione
- 5) Corpo

**BESCHREIBUNG
DER STÜCKE**

- 1) Überwurfmutter
- 2) Klemmring
- 3) Schubhülse
- 4) Dichtung
- 5) Grundkörper

**DESCRIPTION
DES PIÈCES**

- 1) Ecrou
- 2) Bague de serrage
- 3) Douille de butée
- 4) Joint
- 5) Corp

**DESCRIPCIÓN
DE LAS PIEZAS**

- 1) Tuerca
- 2) Anillo de cerrado
- 3) Casquillo prensa
- 4) Junta tórica
- 5) Cuerpo

> COMPANY APPROVAL

Italian Institute of Plastics (IIP) has attested the conformity of Astore brand (property of FIP - Formatura Iniezione Polimeri) to production system to norm EN ISO 9001 (certificate N° 1). FIP has also obtained the certification EN ISO 14001 of his own Environmental Management System. This means how this company is involved in diminishing the impact of his own activities on atmosphere according to norm EN ISO 14001. This implies an improvement of the production process with an efficiency increase, the substantial reduction of the energetic consumption and the optimization of the refusals. The certificate testifies a further step towards a better qualitative standard. Compression fittings, as all other products Astore (brand property of FIP), are "made in Italy".

Fittings, clamp saddles, compression fittings and ball valves are tested for the use in contact with potable water according to DM174/2004 (Italian Ministerial Decree); fittings and ball valves are certified according WRAS (Water Regulations Advisory Scheme) and ACS (Attestation de Conformité Sanitaire). Furthermore, NSF, with the Quality Registration Mark "Origin and Quality Controlled" (OQC), states also the compatibility of the products to convey potable water; detailed list of the certified products is reported in NSF OQC listing on the website www.nsf.org.

L'Istituto Italiano dei Plastici (IIP) ha ufficialmente attestato la conformità del sistema di qualità di "FIP - Formatura iniezione Polimeri" alla norma UNI EN ISO 9001 (certificato N° 1) per l'attività di stampaggio ad iniezione di raccordi e parti di valvole in materiali termoplastici e assemblaggio di valvole. Fip ha anche ottenuto la certificazione UNI EN ISO 14001 del proprio Sistema di Gestione Ambientale, inteso come tutto quanto è in potere dell'azienda per minimizzare l'impatto delle proprie attività sull'ambiente seguendo i requisiti della norma UNI EN ISO 14001.

Questo implica un miglioramento del processo produttivo con un incremento di efficienza, la riduzione sostanziale dei consumi energetici e l'ottimizzazione della gestione rifiuti. Il certificato testimonia un ulteriore passo avanti nell'innalzamento dello standard qualitativo aziendale.

Raccordi, Staffe, Giunti a compressione e valvole a sfera sono testati per verificarne l'idoneità al contatto con acqua potabile secondo il DM174/2004; raccordi e valvole a sfera sono certificati secondo WRAS (Water Regulations Advisory Scheme) e ACS (Attestation de Conformité Sanitaire). Inoltre, NSF, con il marchio OQC (Origine e Qualità Controllata), dichiara anche la compatibilità dei prodotti per il convogliamento di acqua potabile; la lista dettagliata dei prodotti certificati è riportata nel listing OQC di NSF visibile nel sito www.nsf.org.



DW-8616BQ0078



SISTEMA DI GESTIONE
UNI EN ISO 9001 CERT. IIP N° 1
UNI EN ISO 14001 CERT. IIP N° 70

> 510

COUPLING MANICOTTO KUPPLUNG MANCHON MANGUITO

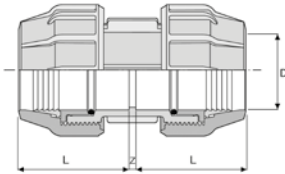

DxD	L	Z	g	Ref.	Pack	Box	Master
16x16	45	4	42	GG.510.160.00	20	360	B
20x20	50	4	66	GG.510.200.00	20	220	B
25x25	57	4	96	GG.510.250.00	10	150	B
32x32	64	4	144	GG.510.320.00	10	100	B
40x40	76	4	242	GG.510.400.00	5	50	B
50x50	88	4	374	GG.510.500.00	5	35	B
63x63	103	9	599	GG.510.630.00	5	20	B
75x75	118	4	905	GR.510.750.00	1	15	B
90x90	136	5	1290	GR.510.900.00	1	11	B
110x110	151	4	1970	GR.510.110.00	1	6	B

> 511

MALE ADAPTOR RACCORDO MASCHIO ANSCHLUSSVERSCHRAUBUNG MIT AUSSENGEWINDE RACCORD MALE EMPALME MACHO

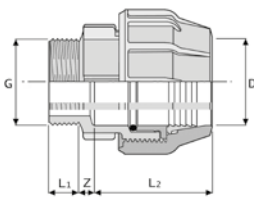

DxG	L1	L2	Z	g	Ref.	Pack	Box	Master
16x3/8"	18	45	16	23	GG.511.16A.00	20	500	B
16x1/2"	18	45	20	23	GG.511.16B.00	20	500	B
16x3/4"	20	45	20	25	GG.511.16C.00	20	500	B
20x1/2"	18	50	18	36	GG.511.20B.00	20	400	B
20x3/4"	20	50	19	38	GG.511.20C.00	20	400	B
25x1/2"	18	57	19	53	GG.511.25B.00	10	250	B
25x3/4"	20	57	20	54	GG.511.25C.00	10	250	B
25x1"	20	57	26	56	GG.511.25D.00	10	250	B
32x3/4"	20	64	23	81	GG.511.32C.00	10	150	B
32x1"	20	64	26	83	GG.511.32D.00	10	150	B
32x1 1/4"	24	64	26	89	GG.511.32E.00	10	150	B
40x1"	20	76	26	137	GG.511.40D.00	5	90	B
40x1 1/4"	24	76	29	140	GG.511.40E.00	5	90	B
40x1 1/2"	24	76	29	143	GG.511.40F.00	5	90	B
50x1 1/4"	24	88	29	214	GG.511.50E.00	5	55	B
50x1 1/2"	24	88	29	214	GG.511.50F.00	5	55	B
50x2"	29	88	34	222	GG.511.50G.00	5	55	B
63x1 1/2"	24	103	29	341	GG.511.63F.00	5	30	B
63x2"	29	103	34	347	GG.511.63G.00	5	30	B
63x2 1/2"	32	103	39	361	GG.511.63H.00	5	30	B
75x2"	29	118	34	520	GR.511.75G.00	1	25	B
75x2 1/2"	32	118	40	516	GR.511.75H.00	1	25	B
75x3"	38	118	43	534	GR.511.75I.00	1	25	B
90x2"	29	136	34	740	GR.511.90G.00	1	16	B
90x2 1/2"	32	136	40	750	GR.511.90H.00	1	16	B
90x3"	38	136	43	750	GR.511.90I.00	1	16	B
90x4"	44	136	49	793	GR.511.90L.00	1	16	B
110x2"	27	150	34	1040	GG.511.11G.00	1	8	B
110x3"	38	151	43	1138	GR.511.11I.00	1	8	B
110x4"	44	151	49	1156	GR.511.11L.00	1	8	B

512 <

REDUCER COUPLING MANICOTTO RIDOTTO KUPPLUNG REDUZIERT MANCHON REDUIT MANGUITO REDUCIDO

DxD1	L1	L2	Z	g	Ref.	Pack	Box	Master
20x16	40,5	50	4	54	GG.512.20A.00	20	260	B
25x20	50	57	4	81	GG.512.25B.00	10	180	B
32x20	50	57,5	4	109	GG.512.32B.00	10	110	B
32x25	53	58	4	123	GG.512.32C.00	10	110	B
40x25	57	76	4	183	GG.512.40C.00	5	70	B
40x32	64	76	4	190	GG.512.40D.00	5	70	B
50x25	57	88	4	262	GG.512.50C.00	5	40	B
50x32	64	88	4	281	GG.512.50D.00	5	40	B
50x40	76	88	4	319	GG.512.50E.00	5	40	B
63x32	64	103	4	403	GG.512.63D.00	5	25	B
63x40	76	103	4	450	GG.512.63E.00	5	25	B
63x50	88	103	4	492	GG.512.63F.00	5	20	B
75x50	88	118	4	664	GR.512.75F.00	1	15	B
75x63	103	118	4	757	GR.512.75G.00	1	15	B
90x63	103	136	4	980	GR.512.90G.00	1	12	B
90x75	118	136	4	1123	GR.512.90H.00	1	12	B
110x75	118	151	4	1502	GG.512.11H.00	1	6	B
110x90	136	151	4	1682	GR.512.11I.00	1	6	B

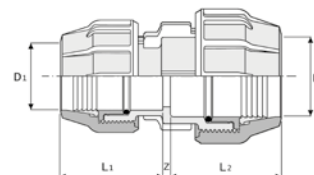

525 <

ADAPTOR WITH NUT ADATTATORE A GHIERA ADAPTER MIT ÜBERWURFMUTTER ADAPTATEUR AVEC ÉCROU ADAPTADOR CON TUERCA

DxG	L	L1	Z	g	Ref.	Box	Pack	Master
25x1"	55	13,2	30	70	GG.525.25D.00	200	10	B
32x1"	57	13,2	33	105	GG.525.32D.00	140	10	B

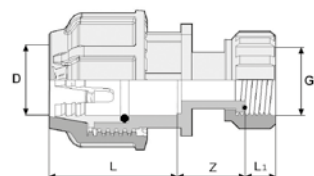

> 601

FEMALE ADAPTOR RACCORDO FEMMINA ANSCHLUSSVERSCHRAUBUNG MIT INNENGEWINDE RACCORD FEMALE EMPALME HEMBRA

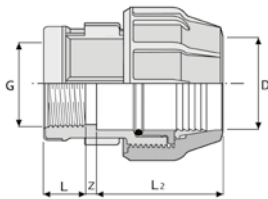

DxG	L	L2	Z	g	Ref.	Pack	Box	Master
16x3/8"	19	45	4	26	GG.601.16A.00	20	500	B
16x1/2"	19	45	4	30	GG.601.16B.00	20	500	B
20x1/2"	19	50	5	41	GG.601.20B.00	20	400	B
20x3/4"	21	50	6	47	GG.601.20C.00	20	340	B
25x1/2"	19	57	3	54	GG.601.25B.00	10	250	B
25x3/4"	21	57	6	61	GG.601.25C.00	10	250	B
25x1"	21	57	8	68	GG.601.25D.00	10	200	B
32x1/2"	19	64	4	85	GG.601.32B.00	10	150	B
32x3/4"	21	64	4	88	GG.601.32C.00	10	150	B
32x1"	21	64	7	95	GG.601.32D.00	10	150	B
32x1 1/4"	25	64	8	100	GG.601.32E.00	10	130	B
40x1"	21	76	4	148	GG.601.40D.00	5	90	B
40x1 1/4"	25	76	4	155	GG.601.40E.00	5	90	B
40x1 1/2"	25	76	6	172	GG.601.40F.00	5	90	B
50x1 1/4"	25	88	4	231	GG.601.50E.00	5	55	B
50x1 1/2"	25	88	6	234	GG.601.50F.00	5	55	B
50x2"	30	88	6	254	GG.601.50G.00	5	55	B
63x1 1/2"	25	103	9	360	GG.601.63F.00	5	30	B
63x2"	30	103	3	374	GG.601.63G.00	5	30	B
75x2"	30	118	7	537	GR.601.75G.00	1	25	B
75x2 1/2"	33	118	4	635	GR.601.75H.00	1	25	B
75x3"	39	118	6	580	GR.601.75I.00	1	25	B
90x2"	30	136	3	700	GR.601.90G.00	1	16	B
90x2 1/2"	33	136	10	730	GR.601.90H.00	1	16	B
90x3"	39	136	10	932	GR.601.90I.00	1	16	B
110x3"	39	151	10	1316	GG.601.11I.00	1	8	B
110x4"	45	151	10	1390	GR.601.11L.00	1	8	B

> 521

PLUG TAPPO BLINDVERSCHRAUBUNG BOUCHON FEMELLE TAPÓN

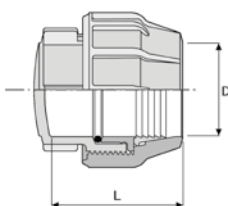

D	L	g	Ref.	Pack	Box	Master
16	45	29	GG.521.160.00	20	500	B
20	50	40	GG.521.200.00	20	400	B
25	57	55	GG.521.250.00	10	250	B
32	64	86	GG.521.320.00	10	150	B
40	76	152	GG.521.400.00	5	90	B
50	88	230	GG.521.500.00	5	60	B
63	103	348	GG.521.630.00	5	30	B
75	118	452	GR.521.750.00	1	28	B
90	136	750	GR.521.900.00	1	22	B
110	151	1031	GR.521.110.00	1	8	B

513 <

ELBOW GOMITO WINKEL COUDE CODO

DxD	L	Z	g	Ref.	Pack	Box	Master
16x16	45	11	45	GG.513.160.00	20	360	B
20x20	50	13	70	GG.513.200.00	20	200	B
25x25	57	15	105	GG.513.250.00	10	150	B
32x32	64	19	161	GG.513.320.00	10	80	B
40x40	76	23	269	GG.513.400.00	5	50	B
50x50	88	28	415	GG.513.500.00	5	30	B
63x63	103	35	656	GG.513.630.00	5	15	B
75x75	118	41	994	GR.513.750.00	1	11	B
90x90	136	49	1450	GR.513.900.00	1	8	B
110x110	151	60	2193	GR.513.110.00	1	4	B

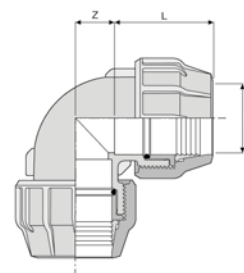

519 <

ELBOW MALE THREADED GOMITO FILETTATO MASCHIO WINKEL MIT AUSSENGEWINDE COUDE TARAUDE CODO FILETADO MACHO

DxG	L1	L2	Z	Z1	g	Ref.	Pack	Box	Master
16x1/2"	45	18	11	40	29	GG.519.16B.00	20	400	B
20x1/2"	50	18	13	46	50	GG.519.20B.00	20	260	B
20x3/4"	50	20	13	46	50	GG.519.20C.00	20	260	B
25x1/2"	57	20	15	52	75	GG.519.25B.00	10	180	B
25x3/4"	57	20	15	52	75	GG.519.25C.00	10	180	B
25x1"	57	20	15	52	75	GG.519.25D.00	10	180	B
32x1"	64	20	19	61	120	GG.519.32D.00	10	110	B
32x1 1/4"	64	24	19	61	120	GG.519.32E.00	10	110	B
40x1 1/4"	76	24	23	69	198	GG.519.40E.00	5	60	B
40x1 1/2"	76	24	23	69	198	GG.519.40F.00	5	60	B
50x1 1/2"	88	24	28	82	305	GG.519.50F.00	5	35	B
50x2"	88	29	28	82	305	GG.519.50G.00	5	35	B
63x2"	103	29	35	96	480	GG.519.63G.00	5	20	B
63x2 1/2"	103	32	35	96	480	GG.519.63H.00	5	20	B
75x2 1/2"	118	32	41	111	709	GR.519.75H.00	1	14	B
75x3"	118	38	41	111	709	GR.519.75I.00	1	14	B
90x3"	136	38	49	128	1031	GR.519.90I.00	1	10	B
110x4"	153	44	58	143	1549	GR.519.11L.00	1	5	B

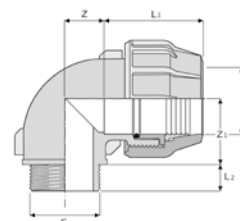

> 518

ELBOW FEMALE THREADED GOMITO FILETTATO FEMMINA WINKEL MIT INNENGEWINDE COUDE TARAUDE CODO FILETADO HEMBRA

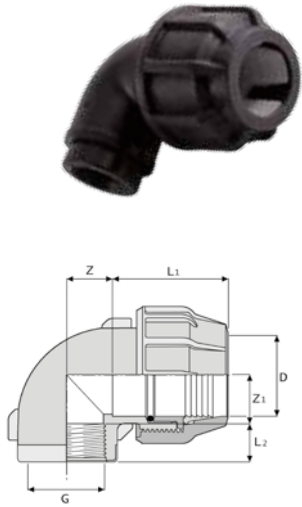

DxG	L1	L2	Z	Z1	g	Ref.	Pack	Box	Master
16x3/8"	45	19	11	25	32	GG.518.16A.00	20	400	B
16x1/2"	45	19	11	28	32	GG.518.16B.00	20	400	B
20x1/2"	50	19	13	28	51	GG.518.20B.00	20	260	B
20x3/4"	57	20	13	28	51	GG.518.20C.00	20	260	B
25x1/2"	57	19	13	28	75	GG.518.25B.00	10	180	B
25x3/4"	57	21	15	31	77	GG.518.25C.00	10	180	B
25x1"	57	21	15	31	77	GG.518.25D.00	10	160	B
32x1/2"	64	19	19	40	122	GG.518.32B.00	10	110	B
32x3/4"	64	21	19	40	122	GG.518.32C.00	10	110	B
32x1"	64	21	19	40	122	GG.518.32D.00	10	110	B
32x1 1/4"	64	25	19	40	122	GG.518.32E.00	10	90	B
40x1 1/4"	76	25	23	44	198	GG.518.40E.00	5	60	B
40x1 1/2"	76	25	23	51	198	GG.518.40F.00	5	60	B
50x1 1/2"	88	25	28	55	316	GG.518.50F.00	5	35	B
50x2"	88	30	28	55	316	GG.518.50G.00	5	35	B
63x2"	103	30	35	63	582	GG.518.63G.00	5	20	B
63x2 1/2"	103	33	35	78	499	GG.518.63H.00	5	20	B
75x2 1/2"	118	33	41	73	810	GR.518.75H.00	1	14	B
75x3"	118	39	41	73	810	GR.518.75I.00	1	14	B
90x3"	136	39	49	87	1213	GR.518.90I.00	1	10	B
110x4"	151	45	60	103	1767	GR.518.11L.00	1	5	B

> 514

TEE RACCORDO A T T STÜCK TÉ 90° T

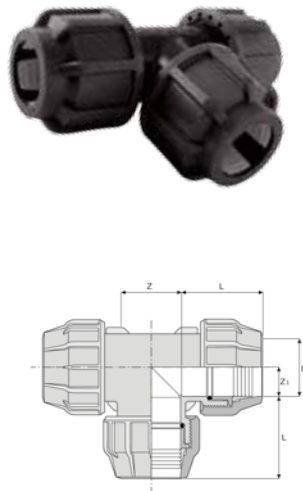

DxDxD	L	Z	Z1	g	Ref.	Pack	Box	Master
16x16x16	45	22	11	66	GG.514.160.00	20	220	B
20x20x20	50	26	13	101	GG.514.200.00	20	120	B
20x25x20	53	26	13	115	GG.514.20C.00	10	120	B
25x25x25	57	30	15	151	GG.514.250.00	10	90	B
25x32x25	54	30	15	190	GG.514.25D.00	10	90	B
32x32x32	64	38	19	236	GG.514.320.00	10	50	B
40x40x40	76	46	23	390	GG.514.400.00	5	30	B
50x50x50	88	56	28	598	GG.514.500.00	5	20	B
63x63x63	103	70	35	944	GG.514.630.00	4	12	B
75x75x75	118	82	41	1427	GR.514.750.00	1	7	B
90x90x90	136	98	49	2113	GR.514.900.00	1	5	B
110x110x110	151	120	60	3191	GR.514.110.00	1	3	B

516 <

TEE MALE THREADED T FILETTATO MASCHIO T STÜCK MIT AUSSENGEWINDE TÉ FILETE T FILETADO MACHO

DxGxD	L1	L2	Z	Z1	g	Ref.	Pack	Box	Master
16x1/2"x16	45	18	22	40	52	GG.516.16B.00	20	240	B
20x1/2"x20	50	18	26	46	82	GG.516.20B.00	20	140	B
20x3/4"x20	50	20	26	46	82	GG.516.20C.00	20	140	B
25x3/4"x25	57	20	30	52	122	GG.516.25C.00	10	100	B
25x1"x25	57	20	30	52	122	GG.516.25D.00	10	100	B
32x1"x32	64	20	38	61	190	GG.516.32D.00	10	60	B
32x1 1/4"x32	64	24	38	61	190	GG.516.32E.00	10	60	B
40x1 1/4"x40	76	24	46	69	322	GG.516.40E.00	5	30	B
40x1 1/2"x40	76	24	46	69	322	GG.516.40F.00	5	30	B
50x1 1/2"x50	88	24	56	82	490	GG.516.50F.00	5	20	B
50x2"x50	88	29	56	82	490	GG.516.50G.00	5	20	B
63x2"x63	103	29	70	96	775	GG.516.63G.00	4	12	B
63x2 1/2"x63	103	32	70	96	775	GG.516.63H.00	4	12	B
75x2 1/2"x75	118	32	82	111	790	GR.516.75H.00	1	10	B
90x3"x90	125	38	97	122	1800	GR.516.90I.00	1	6	B
110x4"x110	144	44	119	143	2523	GR.516.11L.00	1	3	B

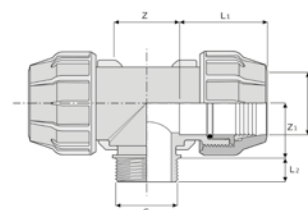

515 <

TEE FEMALE THREADED T FILETTATO FEMMINA T STÜCK MIT INNENGEWINDE TÉ TARAUDÉ T FILETADO HEMBRA

DxG	L1	L2	Z	Z1	g	Ref.	Pack	Box	Master
16x3/8"x16	45	19	22	25	55	GG.515.16A.00	20	240	B
16x1/2"x16	45	19	22	19	48	GG.515.16B.00	20	240	B
20x1/2"x20	50	19	26	27	85	GG.515.20B.00	20	140	B
20x3/4"x20	50	19	26	27	85	GG.515.20C.00	20	140	B
25x1/2"x25	57	19	30	31	127	GG.515.25B.00	10	100	B
25x3/4"x25	57	21	30	31	127	GG.515.25C.00	10	100	B
25x1"x25	57	21	30	35	127	GG.515.25D.00	10	100	B
32x1/2"x32	64	19	38	40	195	GG.515.32B.00	10	60	B
32x3/4"x32	64	21	38	40	195	GG.515.32C.00	10	60	B
32x1"x32	64	21	38	40	195	GG.515.32D.00	10	60	B
32x1 1/4"x32	64	25	38	40	195	GG.515.32E.00	10	50	B
40x1"x40	76	21	46	44	322	GG.515.40D.00	5	30	B
40x1 1/4"x40	76	25	46	44	322	GG.515.40E.00	5	30	B
40x1 1/2"x40	76	25	46	50	322	GG.515.40F.00	5	30	B
50x1 1/2"x50	88	25	56	55	510	GG.515.50F.00	5	20	B
50x2"x50	88	25	56	55	510	GG.515.50G.00	5	20	B
63x2"x63	103	30	70	64	801	GG.515.63G.00	4	12	B
63x2 1/2"x63	103	33	70	64	801	GG.515.63H.00	4	12	B
75x2 1/2"x75	118	33	82	75	1270	GR.515.75H.00	1	10	B
90x3"x90	136	36	98	87	1882	GR.515.90I.00	1	6	B
110x4"x110	151	40	120	103	2780	GR.515.11L.00	1	3	B

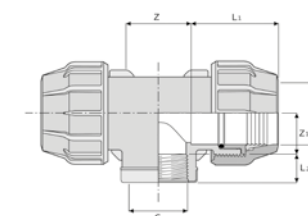

> 520

FLANGE ADAPTOR RACCORDO FLANGIATO ANSCHLUSSVERSCHRAUBUNG MIT FLANSCHANSCHLUSS JOINT A BRIDE EMPALME CON ARANDELA

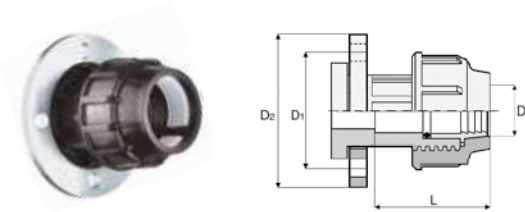

DxDN	L	D1	D2	n°Drill	g	Ref.	Pack	Box	Master
50x1 1/2"	86	110	150	4	1033	GG.520.50F.00	1	12	C
63x2"	98	125	163	4	1217	GG.520.63G.00	1	10	C
75x2 1/2"	118	145	185	4	1843	GR.520.75H.00	1	5	C
75x3"	118	160	200	8	2516	GR.520.75I.00	1	5	C
90x3"	136	160	200	8	2207	GR.520.90I.00	1	3	C
90x4"	136	180	220	8	3190	GR.520.90L.00	1	3	C
110x4"	151	180	220	8	2635	GR.520.11L.00	1	2	C

> 523

REDUCING TEE TI RIDOTTO T REDUZIERT TÉ REDUIT T REDUCIDO



DxD1xD	L	L1	Z	Z1	g	Ref.	Box	Master
25x20x25	51,5	47	30	14	132	GG.523.25B.00	100	B
32x25x32	57,5	51	32	19	207	GG.523.32C.00	60	B
40x32x40	83	75	40	17	340	GG.523.40D.00	40	B
50x40x50	100	90	44	23	580	GG.523.50E.00	20	B
63x50x63	95	85	66	33	950	GG.523.63F.00	12	B

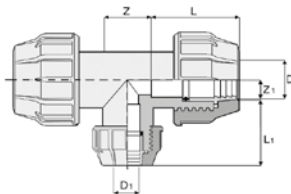

524 <

WALLBRACKETS ATTACCO A MURO WANDSCHEIBE APPLIQUE MURALE CODO GRIFO

DxG	L	L1	L2	Z	A	B	g	Ref	Pack	Box	Master
25x3/4"	83,5	57	21	14	6	62	76	GG.524.25C.00	10	150	B

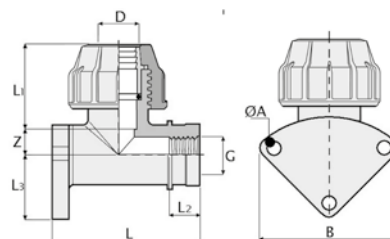

TIGHTENING KEY CHIAVE DI SERRAGGIO SCHLÜSSEL CLE DE SERRAGE LLAVE

D	Ref.	g
40÷63	MAGNUMGRI040063	400
75÷110	MAGNUMGRI075110	1000



> INSTALLATION D 16÷40

1. Cut the pipe at 90° to its axis using a pipe cutter (figure 1).
2. Any burrs and chips resulting from the cutting must be removed.
A small chamfering at the end of the pipe will make the assembly easier.
3. Loosen the joint ring nut to the last thread engaged (the fitting doesn't need to be dismantled).
4. Insert the pipe joint ring into the fitting to the beat and tightly screw the ring nut (figure 2 and 3).

> INSTALLAZIONE D 16÷40

1. Tagliare il tubo a 90° rispetto al suo asse facendo uso di un tagliatubi (figura 1).
2. Eventuali bave e trucioli conseguenti al taglio devono essere rimossi dal tubo.
L'esecuzione di un piccolo smusso all'estremità del tubo faciliterà l'assieme.
3. Allentare la ghiera del giunto sino all'ultimo filetto in presa (non occorre smontare il giunto).
4. Inserire il tubo nel giunto sino a battuta (figura 2) e avvitare la ghiera a fondo (figura 3).

> INSTALLATION D 16÷40

1. Das Rohr bei 90° zu seiner Achse mit Hilfe eines Rohrschneiders abschneiden (Abbildung 1).
2. Eventuelle entstandene Grate und Splitter durch den Schnitt entfernen.
Eine kleine Abschrägung am Ende des Rohres macht die Montage leichter.
3. Die Überwurfmutter des Verbindungsstücks bis zur letzten greifenden Windung lösen (die Verbindung nicht vollständig ausbauen).
4. Das Rohr bis zum Anschlag in das Verbindungsstück einsetzen (Abbildung 2).
5. Die Überwurfmutter wieder fest anziehen (Abbildung 3).



> Fig. 2

> INSTALLATION D 16÷40

1. Couper le tube à 90° par rapport à son axe, en utilisant un coupe-tube (figure 1).
2. Les éventuels bavures et copeaux formés suite à la découpe du tube doivent être enlevés. La réalisation d'un petit chanfrein à l'extrémité du tube facilitera l'assemblage.
3. Desserrer la bague du joint jusqu'à libérer le dernier filet (il ne faut pas démonter le joint).
4. Insérer le tube dans le joint jusqu'à la rainure et visser la bague à fond (figure 2-3).

> INSTALACIÓN D 16÷40

1. Cortar el tubo a 90° respecto a su eje, utilizando un corta tubos (figura 1).
2. Eliminar del tubo las posibles rebabas y virutas que haya producido el corte.
Biselando ligeramente el extremo del tubo se facilitará su empalme.
3. Aflojar la anilla de unión hasta que un solo paso de rosca mantenga la unión (no es necesario deshacer el empalme).
4. Introducir el tubo en el empalme hasta el tope (figura 2).
5. Enroscar hasta el tope la anilla. Hasta el D 32, el apriete de la anilla puede efectuarse manualmente; para el D 40 se recomienda utilizar una llave apropiada (figura 3).



> Fig. 1



> Fig. 3

> INSTALLATION D 50÷63

1. Cut the pipe at 90 ° to its axis using a pipe cutter (figure 1).
2. Any burrs and chips resulting from the cutting must be removed.
3. Insert on the pipe these items in the following order: the ring nut, the clinching ring and put the o'ring onto the pipe inlet. Before carrying out this operation, lubricate the pipe and the seal to ease the insertion (figure 1).
4. Insert the fitting body until the seal beats in the body (figure 2).
5. Tightly screw the ring nut with the proper spanner (figure 3).

> INSTALLAZIONE D 50÷63

1. Tagliare il tubo a 90° rispetto al suo asse facendo uso di un tagliatubi.
2. Eventuali bave e trucioli conseguenti al taglio devono essere rimossi dal tubo.
3. Inserire sul tubo nell'ordine: la ghiera, l'anello di graffaggio, e porre la guarnizione o'ring sulla bocca del tubo. Prima di tale operazione lubrificare il tubo e la guarnizione per agevolarne l'inserimento (figura 1).
4. Inserire il corpo del giunto fino a che la guarnizione sia a battuta nel corpo stesso (figura 2).
5. Avvitare la ghiera a fondo con l'ausilio di chiave di serraggio appropriata.

> INSTALLATION D 50÷63

1. Das Rohr bei 90° zu seiner Achse mit Hilfe eines Rohrschneiders abschneiden.
2. Eventuelle entstandene Grate und Splitter durch den Schnitt entfernen.
3. Das Rohr in der folgenden Reihenfolge einsetzen: die Überwurfmutter, Klemmring und die O-Ring-Dichtung auf die Rohröffnung setzen. Bevor dieser Operation das Rohr und die Dichtung schmieren, um das Einsetzen zu erleichtern (Abbildung 1).
4. Den Körper des Verbindungsstücks einsetzen bis die Dichtung im Körper selbst anschlägt (Abbildung 2).
5. Die Überwurfmutter mit Hilfe eines geeigneten Schraubenschlüssels fest anziehen. (Abbildung 3).

> INSTALLATION D 50÷63

1. Couper le tube à 90° par rapport à son axe, en utilisant un coupe-tube.
2. Les éventuels bavures et copeaux formés suite à la découpe du tube doivent être enlevés.
3. Insérer dans l'ordre sur le tube: la bague, l'anneau de serrage, et poser la garniture o'ring sur l'embout du tube. Avant cette opération, lubrifier le tube et le joint pour faciliter l'insertion (figure 1).
4. Insérer le corps du joint jusqu'à ce que la garniture soit dans la rainure du corps même (figure 2).
5. Visser la bague à fond à l'aide de la clé de serrage appropriée (figure 3).

> INSTALACIÓN D 50÷63

1. Cortar el tubo a 90° respecto a su eje, utilizando un corta tubos.
2. Eliminar del tubo las posibles rebabas y virutas que haya producido el corte.
3. Introducir en el tubo, por este orden: la anilla, el anillo de apriete, el casquillo de empuje (para D 75 y D 90) y poner la junta o' ring en la boca del tubo. Antes de esta operación, para D 75 y D 90 lubricar todo el tubo y la junta para facilitar la introducción (figura 1).
4. Introducir el cuerpo del empalme hasta que la junta toque el tope del cuerpo (figura 2).
5. Deslizar el casquillo y el anillo de apriete por el tubo (figura 3).
6. Enroscar hasta el tope la anilla, con la ayuda de una llave de apriete apropiada.



> Fig. 1

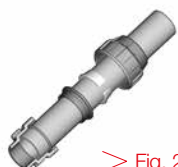

> Fig. 2



> Fig. 3

> INSTALLATION D 75÷110

1. Cut the pipe at 90 ° to its axis using a pipe cutter.
2. Any burrs and chips resulting from the cutting must be removed (figure 4).
3. Insert on the pipe these items in the following order: the ring nut, the presser bush, the o-ring and the fitting body. Before carrying out this operation, lubricate both the pipe and the seal to ease the insertion (figure 5).
4. Tightly screw the ring nut to allow the introduction of the seal until it beats in the body. Unscrew the ring nut, open the clinching ring and insert it into the pipe (figure 6).
5. Tightly screw the ring nut with the proper spanner.

> INSTALLAZIONE D 75÷110

1. Tagliare il tubo a 90° rispetto al suo asse facendo uso di tagliatubi.
2. Inserire il tubo nell'ordine: la ghiera, la bussola di spinta, la guarnizione ed il corpo del giunto. Prima di tale operazione, lubrificare sia il tubo che la guarnizione per agevolarne l'inserimento (figura 4).
3. Serrare a fondo la ghiera per permettere l'introduzione della guarnizione fino alla battuta del corpo (figura 5).
4. Svitare la ghiera, aprire l'anello di graffaggio e inserirlo nel tubo, serrare nuovamente la ghiera a fondo con l'aiuto di chiave di serraggio appropriata (figura 6).

> INSTALLATION D 75÷110

1. Das Rohr bei 90° zu seiner Achse mit Hilfe eines Rohrschneiders abschneiden.
2. Eventuelle entstandene Grate und Splitter durch den Schnitt entfernen. Überwurfmutter, Druckhülse, Dichtung und Körper des Verbindungsstücks in das Rohr in dieser folgenden Reihenfolge einsetzen. Bevor dieser Operation, sowohl den Schlauch als auch die Dichtung schmieren, um das Einsetzen zu erleichtern. (Abbildung 4).
3. Die Überwurfmutter fest anziehen, um die Dichtung bis zum Anschlag des Körpers einsetzen zu können. (Abbildung 5).
4. Die Überwurfmutter lösen, den Klemmring öffnen und in das Rohr einsetzen. (Abbildung 6).
5. Dann die Überwurfmutter mit Hilfe eines geeigneten Schraubenschlüssels wieder fest anziehen.

> INSTALLATION D 75÷110

1. Couper le tube à 90° par rapport à son axe en utilisant un coupe-tube.
2. Insérer dans l'ordre: la bague, la douille de poussée, la garniture et le corps du joint. Avant cette opération, lubrifier le tube et la garniture pour faciliter l'insertion (figure 4).
3. Serrer à fond la douille pour permettre d'introduire la garniture jusqu'à la rainure du corps (figure 5).
4. Dévisser la douille, ouvrir l'anneau de serrage et l'insérer dans le tube (figure 6).
5. Serrer à nouveau la douille à fond à l'aide de la clé de serrage appropriée.

> INSTALACIÓN D 75÷110

1. Cortar el tubo a 90° respecto a su eje, utilizando un corta tubos (figura 1).
2. Introducir en el tubo, por este orden: la anilla, el casquillo de empuje, la junta y el cuerpo del empalme. Antes de esta operación, lubricar el tubo y la junta para facilitar la introducción (figura 4).
3. Apretar la anilla hasta el tope para que la junta pueda entrar hasta el tope del cuerpo (figura 5).
4. Desenroscar la anilla, abrir el anillo de apriete e introducirlo en el tubo, apretar nuevamente hasta el tope la anilla, con la ayuda de una llave de apriete apropiada, (figura 6).



> Fig. 4

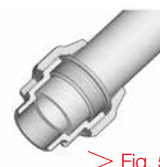

> Fig. 5



> Fig. 6



ASTORE è un marchio di FIP – Formatura Iniezione Polimeri S.p.A.

Stabilimento: Via Tangoni, 26 - 16030 - Casarza Ligure (GE) - Italia
Tel. +39 0185 470811 - Fax +39 0185 466894 - E-mail: astore@astore.it - www.astore.it

FIP – Formatura Iniezione Polimeri S.p.A.

Società Unipersonale - Soggetta a direzione e coordinamento da parte di Aliaxis Holding Italia S.p.A.
Direzione Generale e Sede Legale e stabilimento: Località Pian di Parata - 16015 - Casella (GE) - Italia
Tel. +39 010 9621.1 - Fax +39 010 9621209 - PEC: fip@pec.fipnet.it
C.F. e P. IVA - Iscriz. al Reg. delle Imprese di Genova Nr.: 00276860103
REA C.C.I.A.A. Genova Nr.: 196879 - Cap. Soc.: € 6.200.000
E-mail: info.fip@aliaxis.com - www.fipnet.com

